

Journal of Scientific & Industrial Research

VOLUME 74

NUMBER 1

JANUARY 2015

CONTENTS

Management & Information Technology

11 Analysis of Electricity Price Policy and Economic Growth

Weida He, Chuan Zhang & Rong Hao

This study presents the dynamic influences and changes of economic development on which the electricity price policy impact through theoretical model in China. The results show that from the static point of view, low electricity price level seems to be good for economic benefits. However, from a long-term and dynamic point of view, low electricity prices and economic development is not only having no obvious positive correlation, but instead a significant negative correlation. The emergence of this situation is mainly affected by short-term GDP and government officials in the pursuit of political achievements. In the short-term, low electricity price may promote the economic development.

19 Modified Particle Swarm Optimization Based Adaptive Fuzzy K-Modes Clustering for Heterogeneous Medical Databases

R S Kumar & G T Arasu

The main purpose of data mining is to extract hidden predictive knowledge of useful information and patterns of data from large databases for utilizing it in decision support. Medical field has large amount of various heterogeneous databases, in which the extraction of hidden useful knowledge for the classification of data is difficult one. In order to cluster and classify the whole databases of medical field, a clustering algorithm MPSO-AFKM (Modified Particle Swarm Optimization based Adaptive Fuzzy K-Modes) is introduced. The proposed method works with the two phases clustering and classification for the effective classification of medical database.

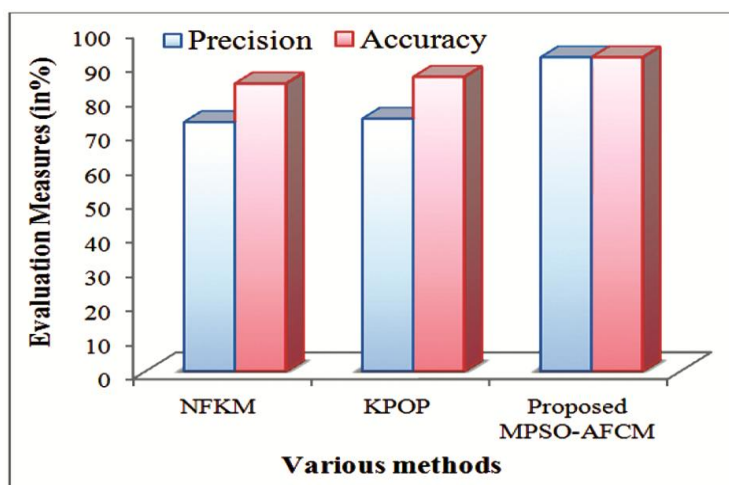

29 An Efficient Data Redundancy Reduction for Sensed Data Aggregators in Sensor Networks

The important issue that is to be discussed in many applications involving Wireless Sensor Network (WSN) is the power efficiency and data aggregation. In this paper, an Efficient Data Redundancy Reduction (EDRR) scheme along with conjugative sleep scheduling algorithm has been proposed. In the existing Localized Power Efficient Data Aggregation Protocol (L-PEDAP), Minimum Spanning Tree based routing scheme was used. In our proposed scheme, CDS based broadcasting is used. This proposed work integrates conjugative sleep scheduler scheme with data redundancy reduction scheme.

K P Sampooram & K Rameshwaran

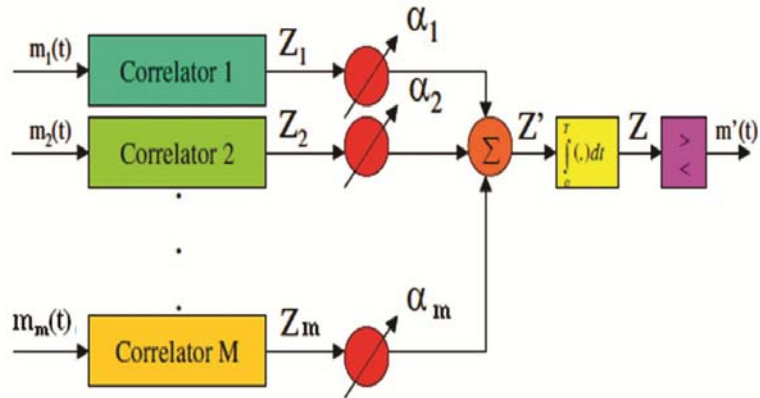

34 Assessment of crop residue potential for power generation using geographical information system

Punjab being a major agricultural state of India produces main crops such as paddy, wheat, pulses, barley, cotton, maize, arhar, mustard, rapeseed, sesamum, sugarcane and ground nut. Presently about half of the crop residue is being utilized for local needs like food for animals, home fuel and thatching materials. Remaining crop residue is being burnt in the field causing national energy loss, environment pollution and decreasing the land fertility. The annual production of total crop residue is 29.46 MT and total unused crop residue as 14.53 MT. Main hurdle for the conversion of crop residue into cleaner energy is its wide spatial distribution across the state. In this paper nature of crop residue, its availability and corresponding energy potential was carried out using geographical information system (GIS) in Punjab.

L Singh & J Singh

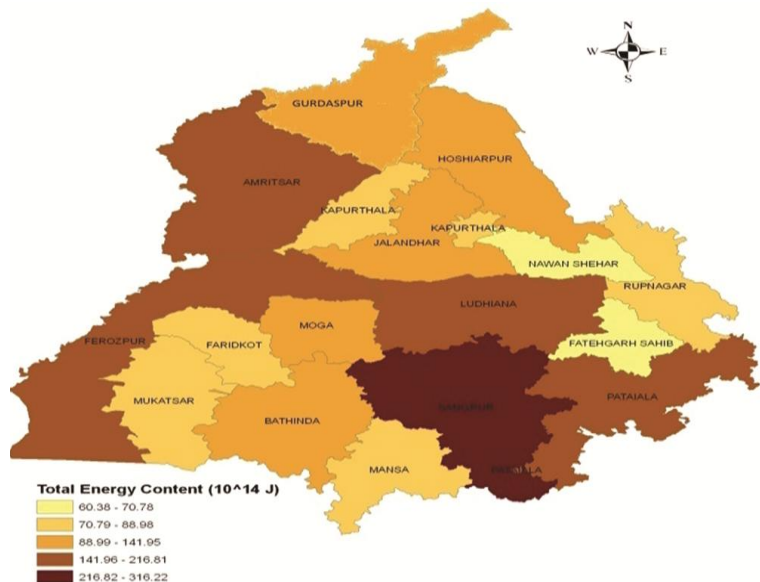

38 Analysis of Node Clustering Algorithms on Data Aggregation in Wireless Sensor Network

One of the most important constraints to be studied in Wireless Sensor Networks (WSNs) is its life time. There are two typical data mining processes that support to reduce the energy consumption of WSN is clustering and data summarization. One of the primary goals of node clustering in WSN is in-network preprocessing that aims to obtain qualified information and to limit the energy consumed. A clustering algorithm is composed of three parts first electing cluster head (CH), selection of cluster membership and transferal data from members to CH. CH relays only one of the aggregated or compressed data packet to sink/ base station. In this paper a brief comparative study is made from different research proposals, which suggests different cluster head selection approaches for data aggregation. The algorithms under this study are Voronoi based K-means clustering algorithm, Voronoi Fuzzy C-means clustering algorithms and Voronoi based Genetic clustering algorithm.

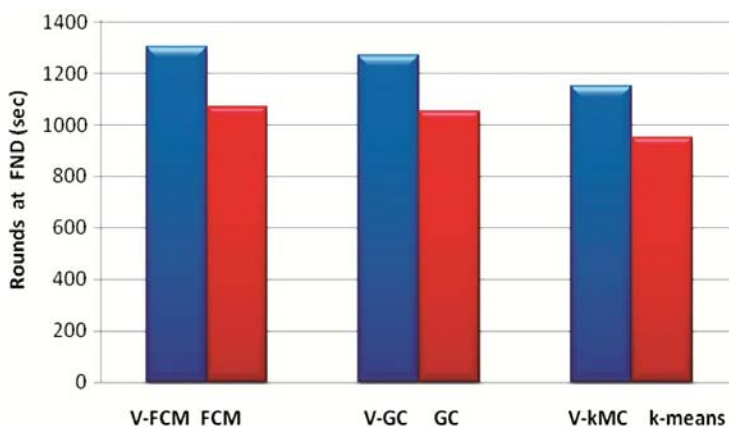

Nithyakalyani & B Gopinath

S & T and Industrial Research

43 Microwave assisted and classical synthesis of symmetric double Schiff bases of 1, 1'-bis(4-amino-3-methylphenyl) cyclohexane and their antimicrobial assay

Symmetric double Schiff bases have been synthesized by microwave assisted and classical facile condensation reaction of aromatic aldehydes and 1,1'-bis(4-amino-3-methylphenyl)cyclohexane. The structure of Schiff bases are supported by FTIR, UV, ¹H NMR and MS techniques. Microwave technique yielded improved reaction yields (88-96) and drastic reduction in reaction time (0.5-2.2 min). They possess mild to comparable antibacterial activity and mild antifungal activity as compared to chosen standard drugs.

V K Aghera, R Y Ghumara & P H Parsania

48 Emission characteristics of sunflower oil based bio-compatible blends of 2T oil

Environmental concerns have increased the interest in bio-lubricants which causes many manufacturers to reconsider vegetable oils as base stocks. In this work, the sunflower methyl ester formation by means of transesterification was studied. Taguchi's methodology (L9 orthogonal array) was chosen for the optimisation of the most important variables (molar ratio, catalyst concentration and stirrer speed) in transesterification process. Maximum yield (90%) of sunflower methyl ester (SFME) percentage was obtained for the base oil-methanol molar ratio of 10:3 with 0.5% by weight of sodium hydroxide (NaOH) stirred at 1100 rpm.

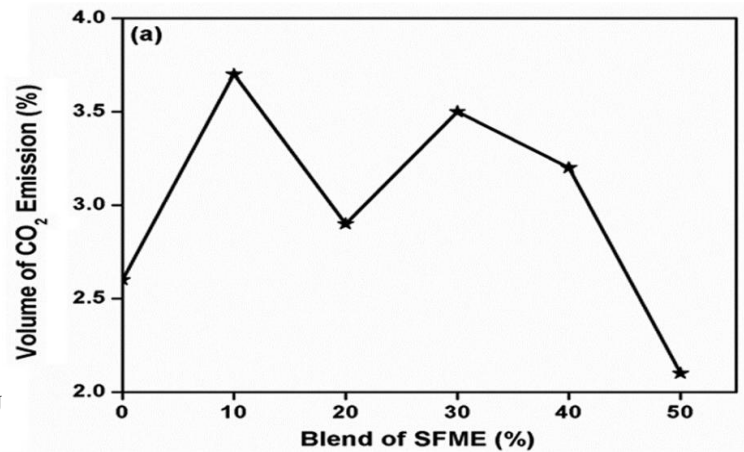

G Senthilkumar, K Balamurugan & J Mohanraj

Energy and Environment

52 Steady State Thermal Analysis of Gas Turbine Power Plant Cycles at Higher Temperatures

Increasing the cost of fuels, growing concern of global warming and increasing demand of electrical energy, a compact, less polluting and efficient gas turbine power plant with regenerator and a suitable Waste Heat Recovery Steam Generator (WHRS) presents a very attractive concept. Developments in metallurgical sciences, protective coatings and cooling methods have provided the options to design the components and a higher Turbine Inlet Temperature (TIT) may be achievable in near future. A design and analysis methodology for thermodynamic evaluation of the gas turbine cycles has been developed, validated and applied for the analysis.

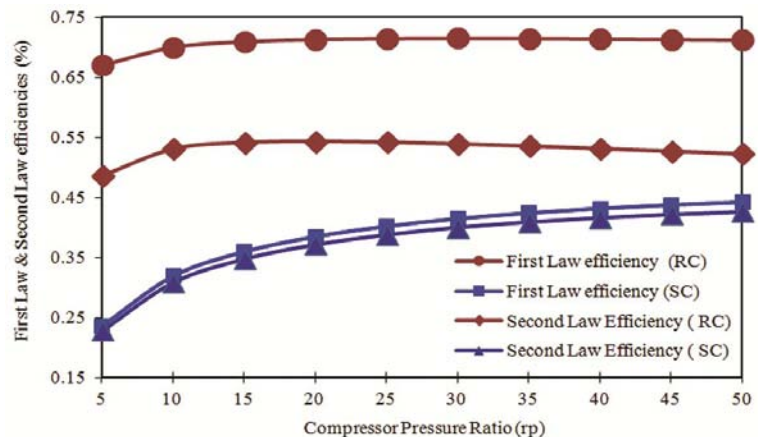

A Kumar, S S Kachhwaha & R S Mishra

Waste Utilization

58 Quantitative industrial Analysis of Lignocellulosic Composition in Typical Agro- Residues and Extraction of Inner Hemicelluloses with Ionic Liquid

The contents of cellulose, hemicelluloses and lignin were first analyzed and compared in three agro-industrial residues; and then a new method was developed to extract hemicelluloses with ionic liquid. The study investigated the effect of the extraction conditions and optimized them by Box-Behnken experiment design. When the ionic liquid concentration was 30.08 %, temperature was 90.31 °C, reaction time was 4.10 h and the ratio of liquid/solid was 25.97, the yield of hemicelluloses could reach 52.02 %. The green extraction solvent could be efficiently recycled for five times. Moreover, the chemical structure and thermal stability of obtained hemicelluloses were characterized.

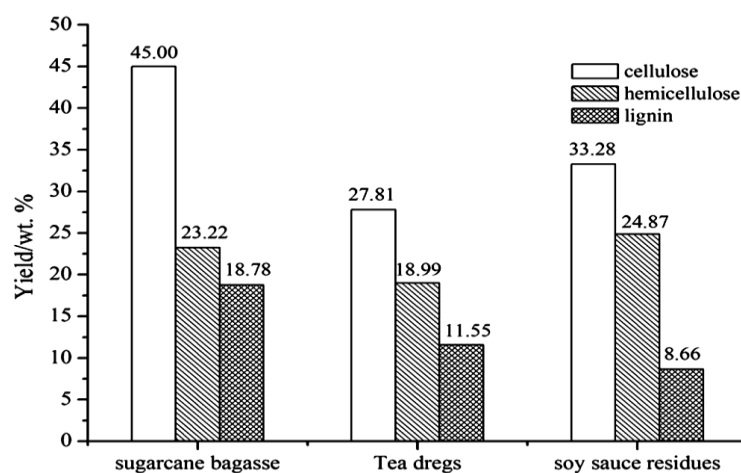

Shun Yao, Ying-ying Yang, Hang Song,
Yan Wang & Hai-qing Wan

Author-Reader Platform

64 Instruction to Contributors
